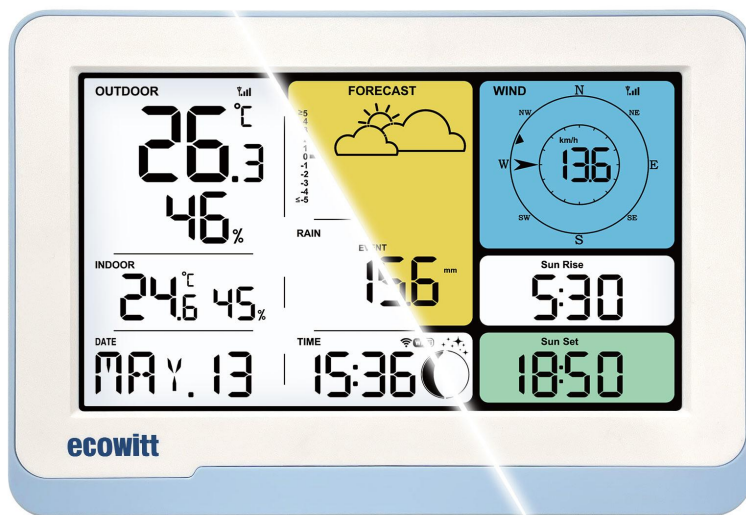


ecowitt®



Weather Station Receiver Manual

Model: WS3800

WS3820



<https://s.ecowitt.com/FD6USP>

Table of Contents

1. Introduction.....	4
2. Installation.....	5
2.1 Part List.....	5
2.2 Wi-Fi Configuration.....	5
2.2.1 Power-up.....	5
2.2.2 Download the Ecowitt App.....	6
2.2.3 Connect the Station to Wi-Fi via Ecowitt App.....	7
2.2.4 Web Page 192.168.4.1.....	11
2.2.5 Device Location, Timezone, DST, and Data Public.....	14
2.2.6 Replacing Wi-Fi Router.....	15
2.3 Adding Sensors.....	15
2.4 Upload Data to Server.....	16
3. Instructions for Use.....	17
3.1 Multiple Views and Size.....	17
3.2 Features.....	19
3.3 Icon Explanation.....	21
3.3.1 Date & Time.....	22
3.3.2 CO ₂ /PM1.0/PM2.5/PM10/AQI.....	23
3.3.3 Weather Forecast.....	24
3.3.4 Pressure Trend Function.....	25
3.3.5 Wi-Fi Icon.....	25
3.3.6 Indoor Temperature, Humidity, and Pressure.....	26
3.3.7 Outdoor Temperature and Humidity.....	26
3.3.8 Wind.....	26
3.3.9 Rainfall.....	27
3.3.10 UVI.....	28
3.3.11 Moon Phase.....	29
3.3.12 Feels Like.....	29
3.4 LCD Display Brightness.....	30
3.5 Buttons.....	31
3.6 Product Modes.....	33
3.6.1 Normal Mode.....	33
3.6.2 Setting Mode.....	35
3.6.3 Max/Min Value Mode.....	35
3.6.4 Alarm Setting Mode.....	36
3.6.5 MAC Address Display.....	37
3.7 Historical Data Export and Clear.....	37
3.7.1 Export History Data.....	37

3.7.2 Clear History Data	38
3.8 Firmware Upgrade	39
4. Optional Sensors	40
4.1 Sensors	40
4.1.1 Sensor Data Can be Displayed on the WS3800/WS3820	41
4.1.2 Sensor Data Can Only be Uploaded to the Cloud	43
4.2 IoT Device	44
4.2.1 Method 1 to Add Sub-device	44
4.2.2 Method 2 to Add Sub-device	45
5. Calibration	47
5.1 Data Calibration	47
5.2 Rainfall Calibration	48
6. Others	49
6.1 Lightning Distance Unit	49
7. Specifications	50
8. Warranty and Certification	51
8.1 Warranty	51
8.2 FCC	52
9. Care and Maintenance	53
10. Contact Us	54
10.1 After-sales Service	54
10.2 Stay in Touch	54

1. Introduction

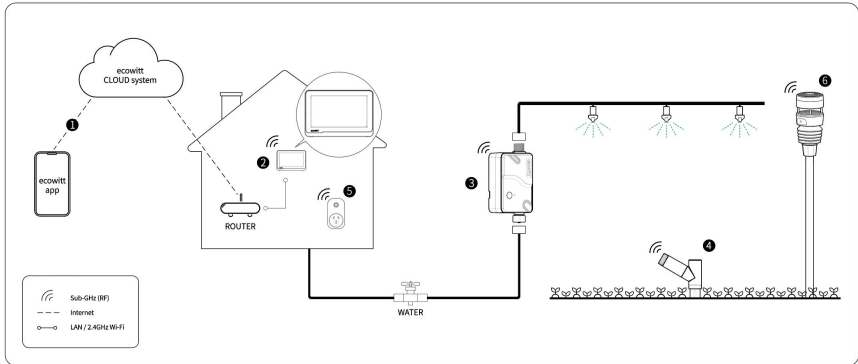


Figure 1: How Ecowitt system works

Thank you for your purchase of Ecowitt WS3800/WS3820 weather station receiver.

Ecowitt WS3800 has a 7.5" LCD white screen, and WS3820 has a 7.5" LCD color screen, both are Wi-Fi weather station receivers. They support monitoring indoor and outdoor conditions, and have built-in temperature, humidity, and barometric pressure sensors, and can connect almost all Ecowitt transmitters with the same RF frequency to use together, to get accurate weather data including wind speed, wind direction, rainfall, UV, solar radiation, outdoor temperature, outdoor humidity, dew point, feels like, CO₂, PM1.0, PM2.5, PM10 and more.

Meanwhile, they support connecting IoT devices, such as WFC01 and AC1100, to achieve smart control through Ecowitt App, which are powerful weather station receivers.

WS3800/WS3820 supports connecting to a 2.4 GHz Wi-Fi network for viewing data from anywhere on your phone, tablet, and computer browser, all for free.

Just so you know, the WS3800/WS3820 needs to be used with optional sensors to obtain outdoor weather data and is not a standalone product.

The following user guide provides step by step instructions for installation and operation. Use this manual to become familiar with your

professional weather station and save it for future reference.

2. Installation

2.1 Part List

1 x WS3800/WS3820 Weather Station Receiver

1 x User Manual

1 x DC to USB Cable

2.2 Wi-Fi Configuration

2.2.1 Power-up

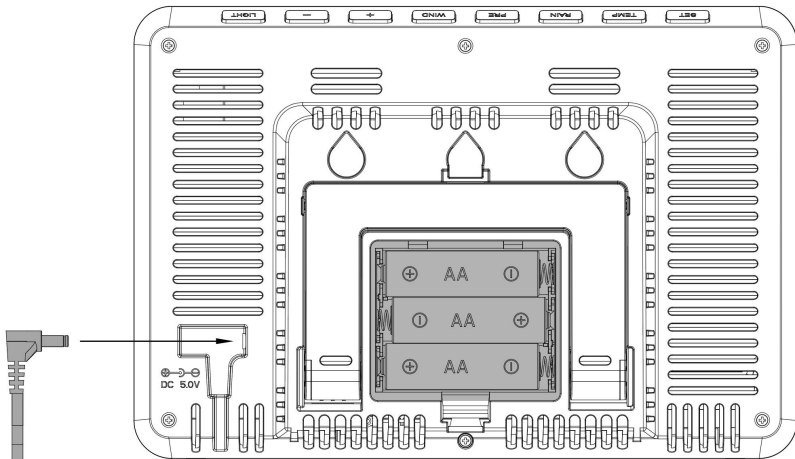


Figure 2: Power-up

Insert the 5V 1A Power Adapter into an outlet, and then plug it into the Power Jack on the back of the station. Optional: Insert 3 fresh AA alkaline or lithium batteries (not included) into the Battery Compartment to power the station on.

The software version number and frequency are displayed for 1 second, then the full screen is displayed for 3 seconds and finally enters normal mode.

2.2.2 Download the Ecowitt App

Visit the App Store or Google Play Store or scan the QR code below to download the free Ecowitt App onto your mobile device.

Open the Ecowitt App, follow the on-screen setup instructions to create an account, add a new device, and follow **Section 2.2.3** or **2.2.4** below to connect your station to your Wi-Fi network.



Figure 3: Download Ecowitt App

Note: For **Section 2.2.3** or **2.2.4** below (2 ways to complete Wi-Fi configuration), you'll need your Wi-Fi network name (SSID) and password.

2.2.3 Connect the Station to Wi-Fi via Ecowitt App

(1) Open Ecowitt App → "My Devices" → "Add New Devices" → click WS3800/WS3820 icon → choose WiFi Provisioning:

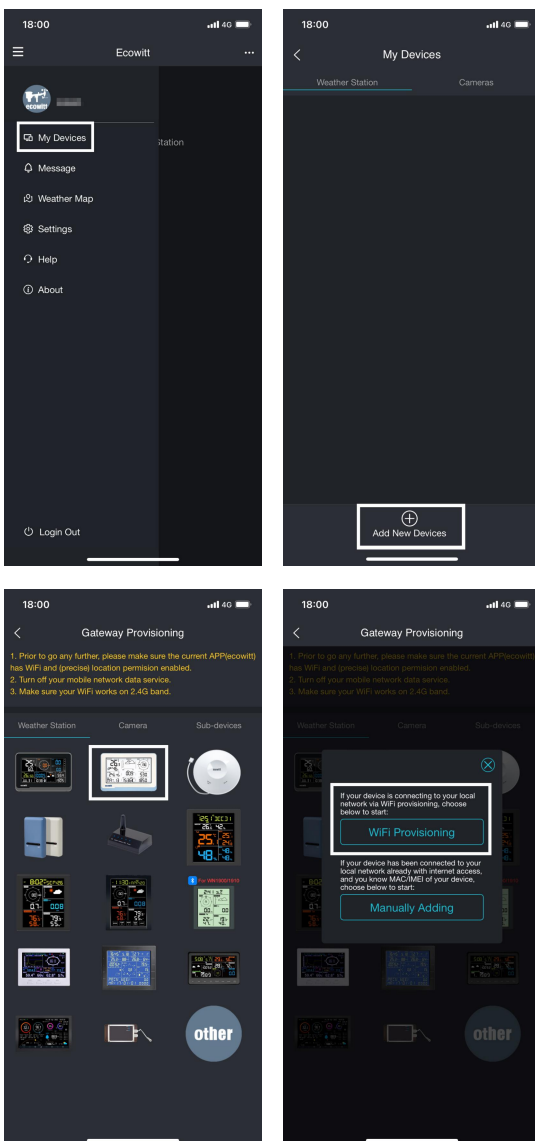


Figure 4

(2) Hold WS3800/WS3820's button **TEMP** + **⏏** for more than 2s in normal mode will turn on its hotspot, Wi-Fi icon will flash fast on the screen. Use mobile phone to connect to the hotspot "WS3800x-WIFIxxxx"/"WS3820x-WIFIxxxx"emitted by the receiver. Then tick "Operation Completed"→"Next".

Note:

1. The Wi-Fi function does not turn on when the device is running solely on battery power.
2. WS3800x-WIFIxxxx, the first x represents the frequency, A=868MHz, B=915MHz, C=433MHz, xxxx represents the last 4 digits of the product MAC address.

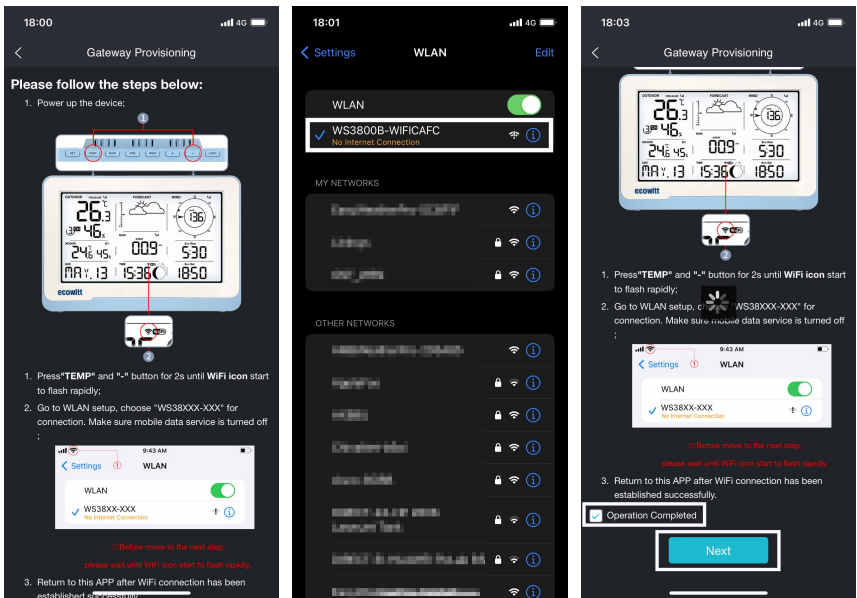


Figure 5

(3) Allow location access, recommend selecting "While Using the App". Then return to the Ecowitt App.

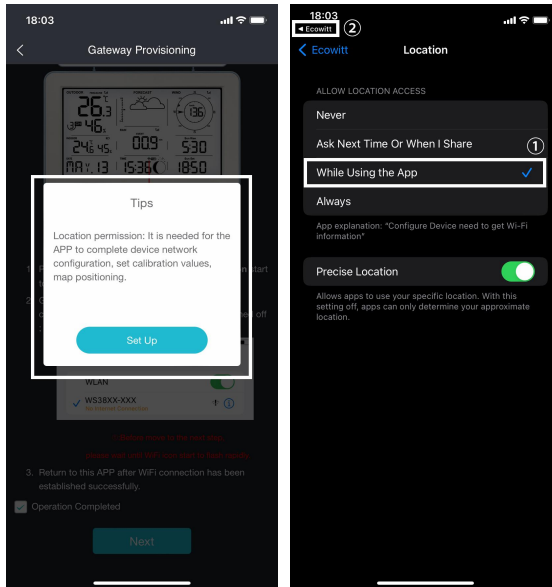


Figure 6

(4) Fill in the Wi-Fi SSID and password, then click "Submit".

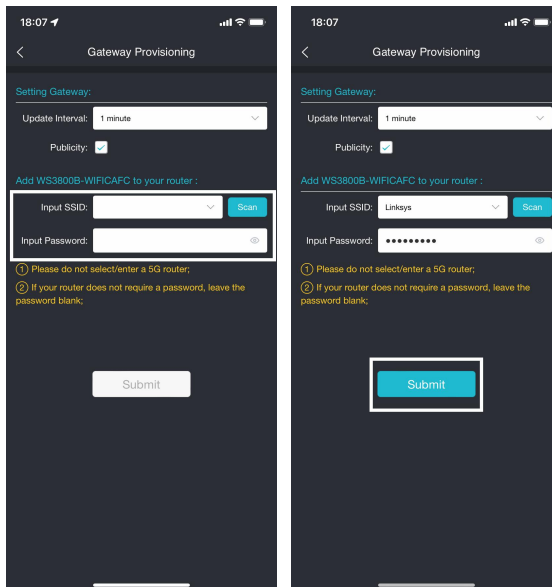
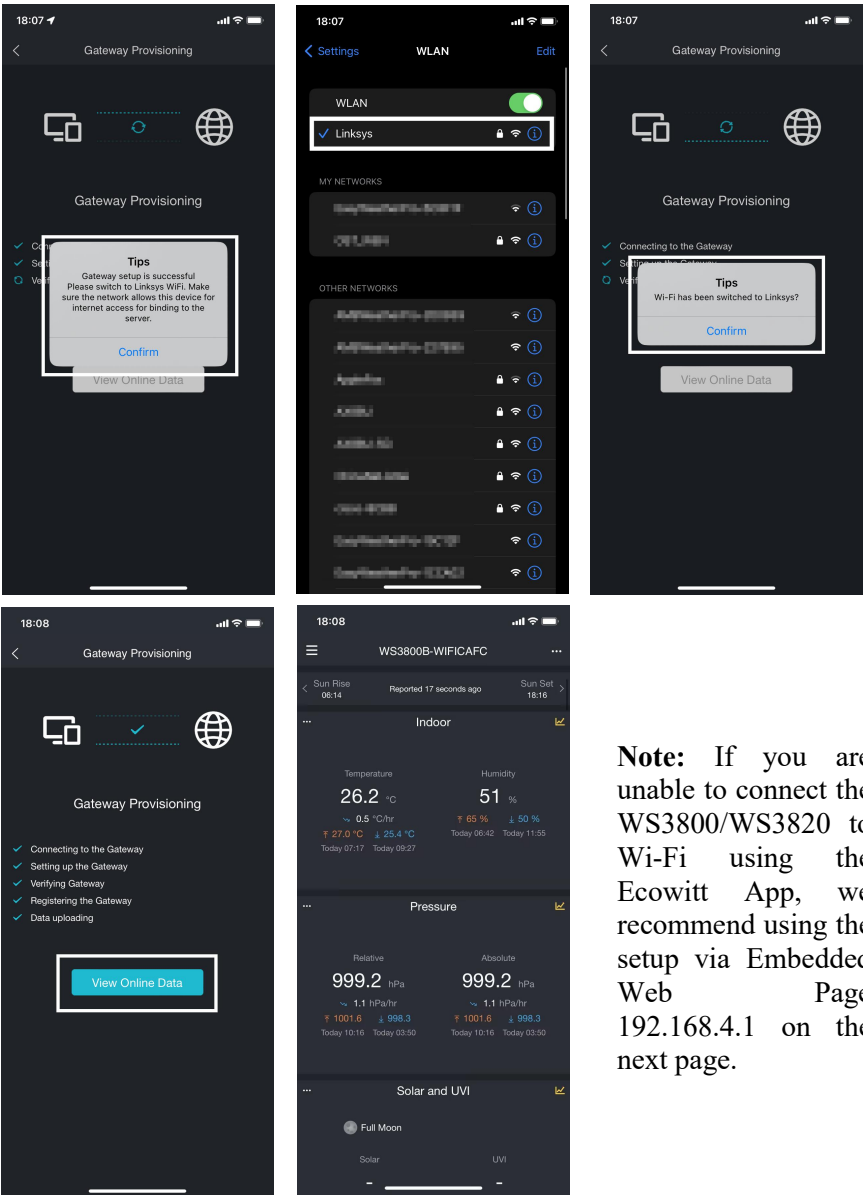


Figure 7

(5) Now the gateway setup is successful. Switch the network of phone to the same Wi-Fi WS3800/WS3820 is connected to. The receiver has been successfully added to the App, then the data can be viewed online.



Note: If you are unable to connect the WS3800/WS3820 to Wi-Fi using the Ecovitt App, we recommend using the setup via Embedded Web Page 192.168.4.1 on the next page.

Figure 8

2.2.4 Web Page 192.168.4.1

(1) Hold **TEMP** + **[]** to turn on WS3800/WS3820's hotspot and connect to this hotspot with your mobile device. Use mobile browser to search the URL: 192.168.4.1. No password is set by default. Click login.

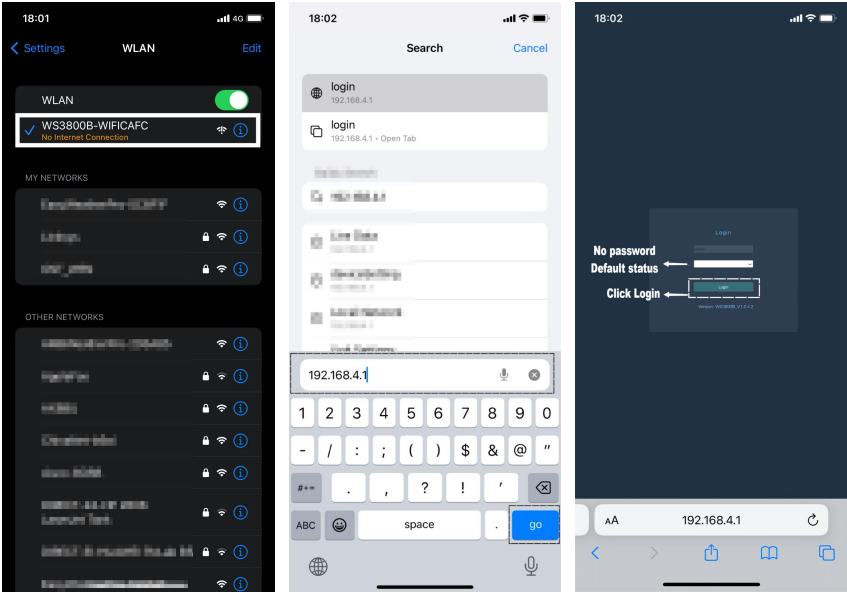


Figure 9

(2) Click Local Network. Input the name and password of the router.

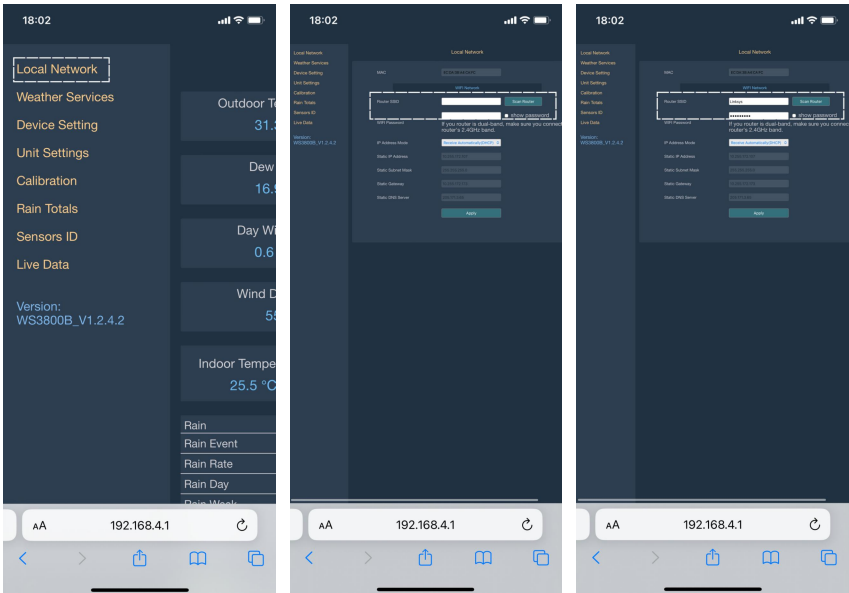


Figure 10

(3) Now the WS3800/WS3820 is successfully connected to the Wi-Fi router. Copy the MAC address for the following steps.

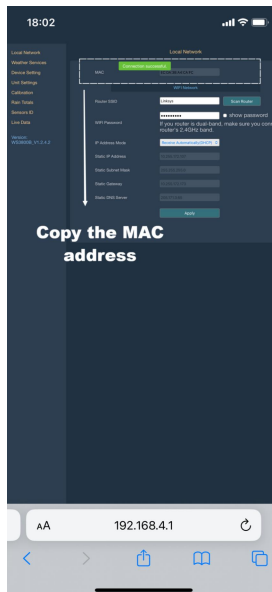


Figure 11: Copy the MAC address

(4) Switch the network of phone to the same Wi-Fi WS3800/WS3820 is connected to. Open Ecowitt App → "My Devices" → "Add New Devices" → click WS3800/WS3820 icon → choose Manually Adding.

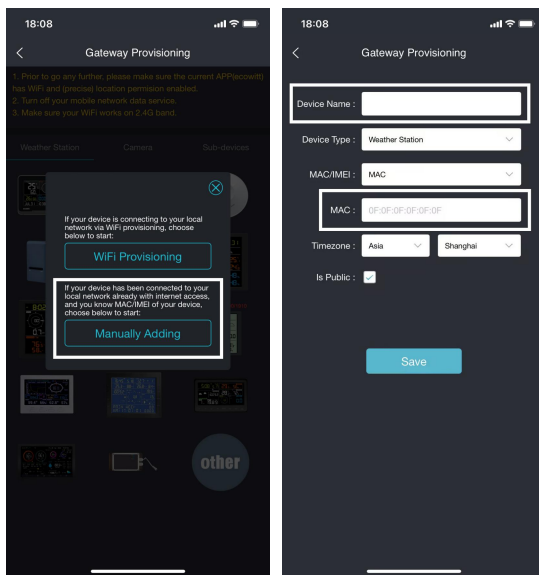


Figure 12

(5) Edit the Device Name and paste the MAC address copied in step (3) into the box, and click "Save", then the data can be viewed online.

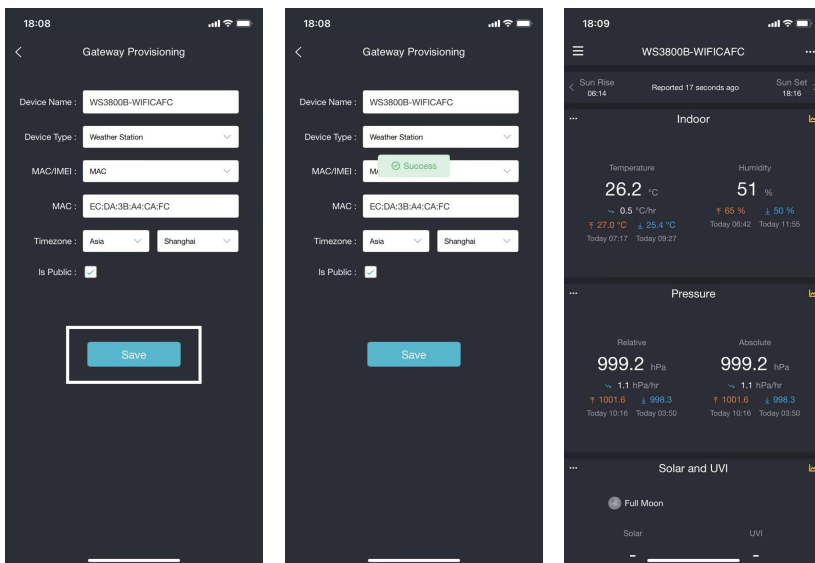


Figure 13

2.2.5 Device Location, Timezone, DST, and Data Public

After completing the Wi-Fi configuration, follow these steps for Device location, Timezone, DST (Daylight Saving Time), and Data public settings.

1. Click on "My Devices".
2. Click on the "... " icon.
3. Set the Device's location and Timezone on this interface. Tick "Auto DST" and "Is Public" when necessary.
4. Click "Save", then reboot the WS3800/WS3820, the receiver will automatically synchronize time and DST.

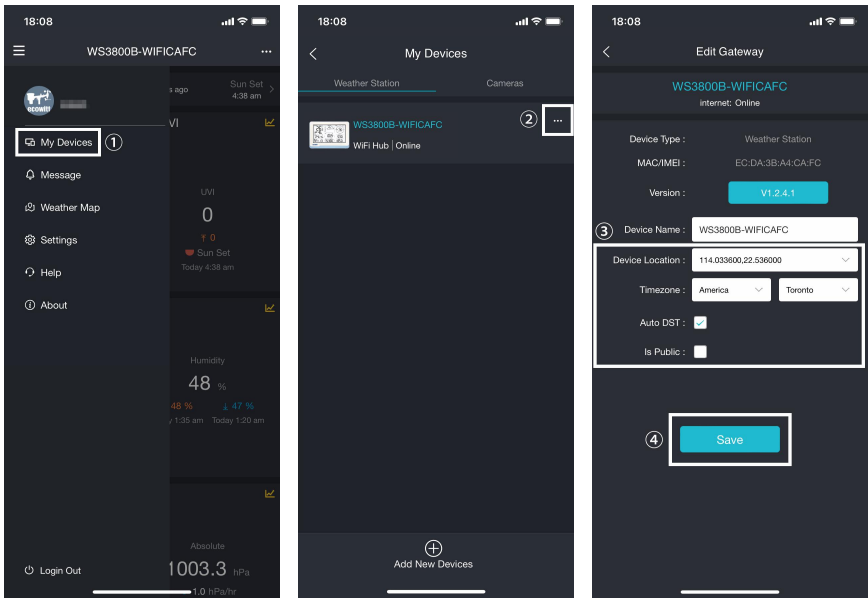


Figure 14: Related settings via Ecowitt App

Note: After completing the above Wi-Fi configuration and related settings, the WS3800/WS3820 screen will display a stable Wi-Fi signal tower, auto time zone, and DST (when necessary).



Figure 15: WS3800/WS3820 sync App related settings

2.2.6 Replacing Wi-Fi Router

If you want to change your router, follow **Section 2.2.3** or **2.2.4** again after restoring the gateway to its factory settings (Hold **SET** + **LIGHT** for a factory reset).

2.3 Adding Sensors

To pair the optional sensors (refer to **Section 4** for more optional sensors) with the WS3800/WS3820, please do as follows:

1. Power the sensor on and place it next to the console.
2. Wait for 1~2 minutes, check whether the console will pick up the sensor data automatically and display it on the screen or App.
3. If data is not received from a registered sensor, the RF icon will decrease the signal by one frame; if data is received, the RF icon will increase the signal by one frame.
4. If data is not received, try the following: after making sure the phone and WS3800/WS3820 are connected to the same Wi-Fi network, open the Ecovitt App→Sensor ID→enter the Sensor Management page.
5. In the Sensor Management page, find the sensor you want to pair, select the ID number box and register it.
6. Once successful, you may return to the main interface to check the data.
7. If you know exactly the sensor ID, and want the WS3800/WS3820 to pair that sensor only, you may enter the sensor ID, and save the change to make it effective.

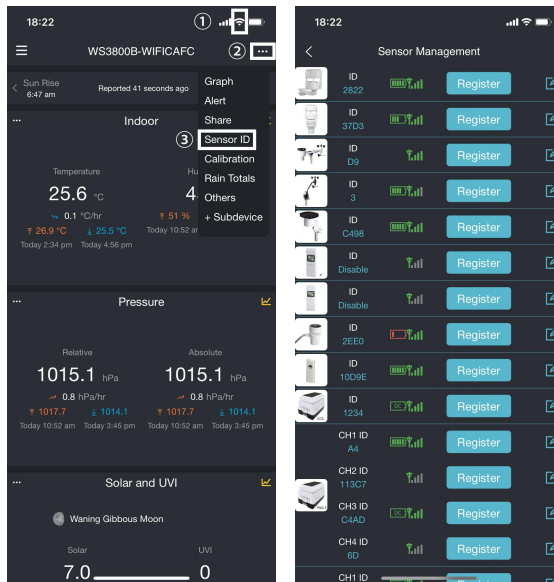


Figure 16: Sensor Management page

2.4 Upload Data to Server

After the Wi-Fi configuration is successful, data can be uploaded to the following weather station servers:

- A. ecowitt.net (Default upload to this server)
- B. wunderground.com
- C. weathercloud.net
- D. wow.metoffice.gov.uk
- E. Customized servers

Upload servers management:

- (1) Ensure that the mobile phone and WS3800/WS3820 receiver are using the same Wi-Fi.
- (2) Ecowitt App → "... " at the top right corner → "Others" → "DIY Upload Servers".

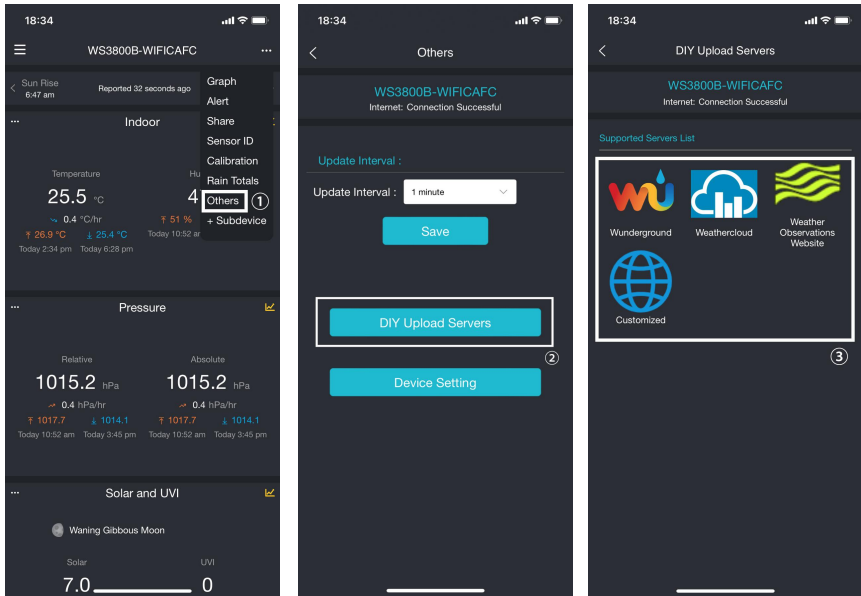


Figure 17: Upload data to server

3. Instructions for Use

3.1 Multiple Views and Size

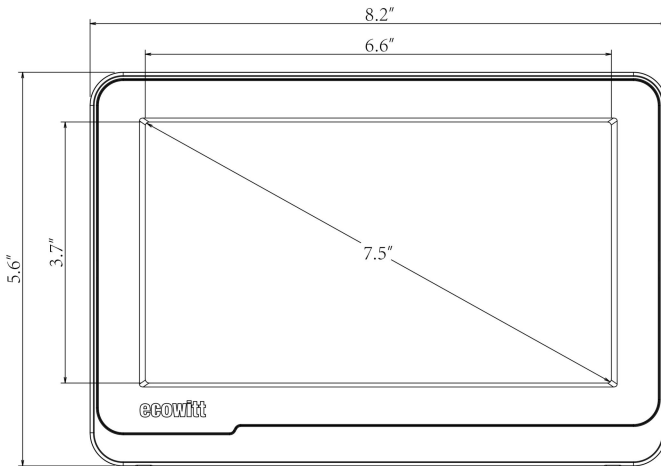


Figure 18: Main view

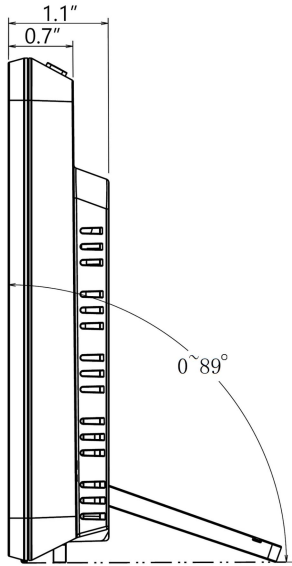


Figure 19: Right view

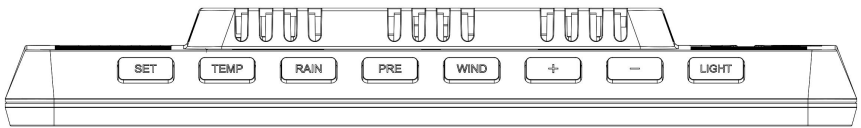


Figure 20: Top view

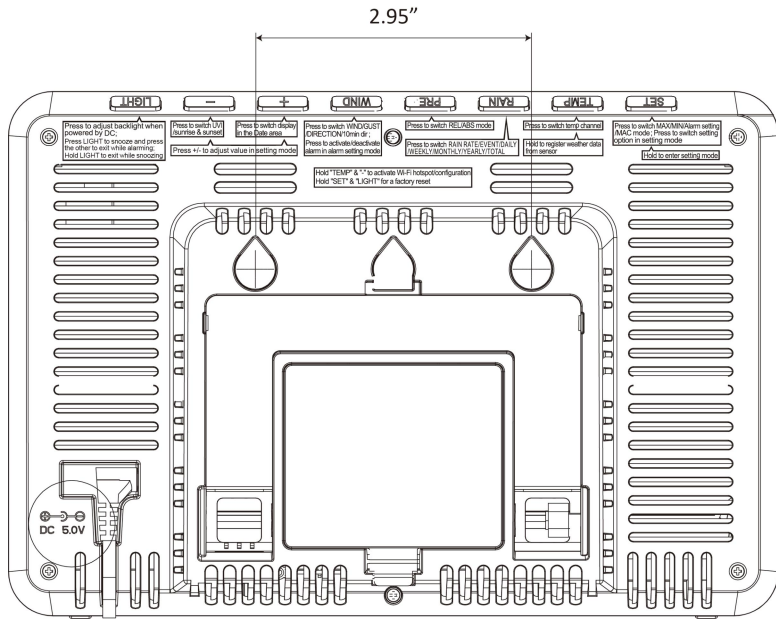


Figure 21: Rear view (Refer to Section 3.5 for Button functions)

3.2 Features

- WS3800: 7.5" LCD, white screen
WS3820: 7.5" LCD, color screen
- 8 physical buttons
- Support DC powered and 3 x AA alkaline or lithium batteries powered (3 fresh AA batteries (not included) can only run for 15-25days. Only used as a short-term backup power)
- Calendar, date, time, moon phase, sunrise, and sunset
- Built-in temperature humidity sensor, and barometric pressure sensor
- Support displaying indoor temperature, humidity, pressure, and changing trend
- Support receiving and displaying 8 channels temperature and humidity sensor data
- Support receiving and displaying wind speed, wind direction,

rainfall, UV, solar radiation, feels like, dew point, CO₂, PM1.0, PM2.5, PM10, and AQI data

- Weather forecast: Sunny, Partly Cloudy, Cloudy, Rainy, Stormy, Snowy and Storm Snowy
- Record Max & Min value
- Alarm & Snooze function
- Support unit setting
- Support DST (Daylight Saving Time)
- RST function (Clear daily max/min values)
- Support backlight adjustment under DC power supply
- Can be used as a Wi-Fi gateway to support the reception of more sensors' data, which can be viewed through the web page
- Support Wi-Fi configuration on the web page (192.168.4.1), view more sensor data, set up server, set up calibration parameters, set up sensor ID
- Data storage on Ecowitt server: <https://ecowitt.net>
- Support uploading data to the weather station server after connecting to the Wi-Fi network:
 - ecowitt.net (Default upload to this server)
 - wunderground.com
 - weathercloud.net
 - wow.metoffice.gov.uk
 - Customized servers
- Support optional sensors, please refer to **Section 4**

3.3 Icon Explanation

See Figure 22 to help you identify icons of the console's display screen.

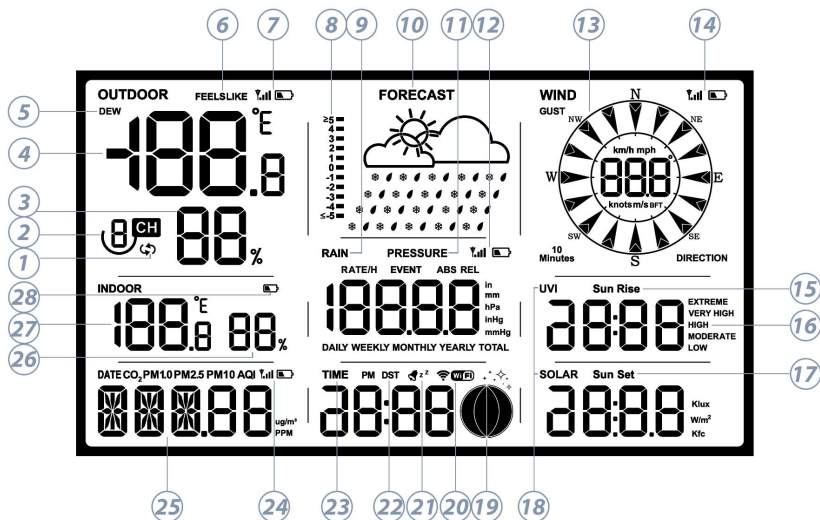


Figure 22

No	Description	No	Description
1	Auto-Scroll	2	Multi-channel temperature and humidity sensors
3	Outdoor humidity	4	Outdoor temperature
5	Dew point	6	Feels like/Apparent temperature
7	RF signal bar and low battery power indicator for WS69 outdoor sensor array or WN30/31/36 multi-channel sensors	8	Pressure trend function
9	Rain Rate/Event/Daily/Weekly/Monthly/Yearly/Total	10	Weather forecast
11	ABS/REL pressure	12	RF signal bar and low battery power indicator for WH40 rain gauge sensor

13	Wind speed/Gust/Direction/ 10min direction	14	RF signal bar and low battery power indicator for WS90/WS85/WS80/WS68 outdoor sensor array
15	Sunrise	16	Range of variation of UV index (EXTREME/VERY HIGH/HIGH/MODERATE/LOW)
17	Sunset	18	UVI & Solar radiation
19	Moon phase	20	Wi-Fi signal bar
21	Alarm & Snooze	22	DST (Daylight Saving Time)
23	Time	24	RF signal bar and low battery power indicator for WH45/WH46 air quality sensor
25	Date/CO ₂ /PM1.0/PM2.5/ PM10/AQI	26	Indoor humidity
27	Indoor temperature	28	Low battery power/no battery indicator for WS3800/WS3820

Table 1: Icon explanation

3.3.1 Date & Time

The date and time will be automatically updated when the Wi-Fi configuration is finished, and the automatic time zone is set. (refer to **Section 2.2** for Wi-Fi configuration)



Figure 23: Date & Time

Every 5 seconds, switch the display between the month and day of the week in the same area.

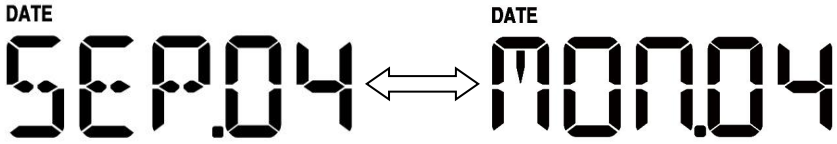



Figure 24: Month & Week

3.3.2 CO₂/PM1.0/PM2.5/PM10/AQI

WS3800/WS3820 supports connecting one WH45 or one WH46 air quality sensor and displaying CO₂/PM1.0(only WH46)/PM2.5/PM10/AQI data. Air quality data share the same display area with Date, which can be switched by pressing the  button.

Note: PM4.0, temperature, and humidity (measured by WH46) readings are only available in the Ecowitt App or web page, not on the display. Temperature and humidity measured by WH45 are also the same.

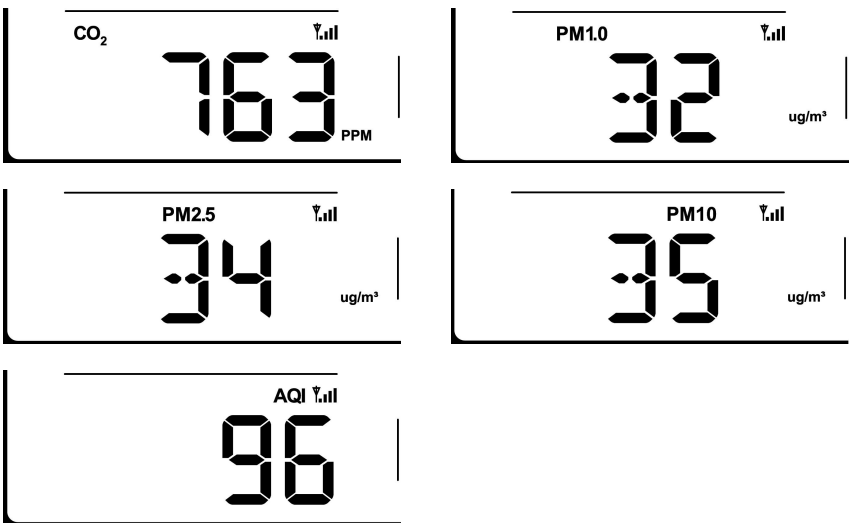


Figure 25: CO₂/PM1.0/PM2.5/PM10/AQI

3.3.3 Weather Forecast

Weather forecast is based on learning the local air pressure over a period (at least one month) and then making a prediction of the weather for the day ahead based on the change in air pressure.

There are seven weather conditions: Sunny, Partly Cloudy, Cloudy, Rainy, Stormy, Snowy and Storm Snowy.

Rain/snow will blink when in a Stormy/Storm Snowy condition. When the outdoor temperature is below 32°F (0°C) and the weather forecast is Rainy or Stormy, the display will show the Snowy condition.





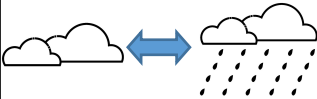

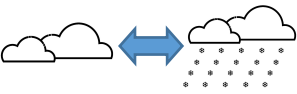
Sunny	Partly Cloudy	Cloudy
		
Pressure increases for a sustained period of time	Pressure increases slightly or initial power up	Pressure decreases slightly
Rainy	Stormy	Snowy
		
Pressure decreases for a sustained period of time	Pressure rapidly decreases	Pressure decreases for a sustained period of time, and temperature $\leq 0^{\circ}\text{C}$
Storm Snowy		
		
Pressure rapidly decreases, and temperature $\leq 0^{\circ}\text{C}$		

Table 2: Weather forecast

3.3.4 Pressure Trend Function

Indicates the difference between the current barometric pressure and the average barometric pressure over the past 30 days.

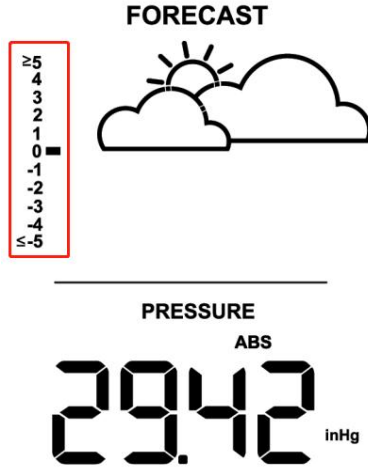


Figure 26: Pressure Trend

3.3.5 Wi-Fi Icon

Wi-Fi Icon Status	Description
Flash	Situation 1: Device power up or hold TEMP + . Situation 2: WS3800/WS3820 is not connected to the router.
Slow flash	WS3800/WS3820 is connected to the router but has no internet access. The data hasn't been successfully uploaded.
Constant light	The data has been uploaded to the server. The Wi-Fi icon indicates the signal strength.

Table 3: Wi-Fi icon

3.3.6 Indoor Temperature, Humidity, and Pressure

WS3800/WS3820 has a built-in temperature & humidity sensor, and a barometric pressure sensor. The WN32P can be used to replace the built-in sensor data.

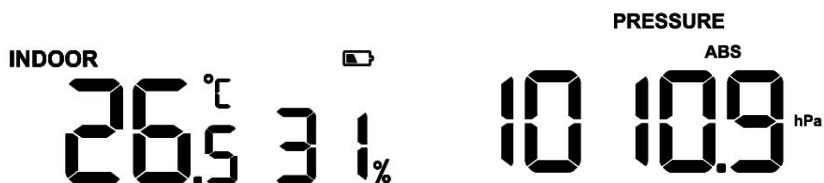


Figure 27: Indoor temperature, humidity, and pressure

3.3.7 Outdoor Temperature and Humidity

Temperature and humidity display priority:



3.3.8 Wind

1. Wind display priority:



2. Wind values and units:

When the wind speed unit is selected via buttons (refer to **Section 3.6.2** to adjust the unit) or web page 192.168.4.1 (Unit Settings), the WS3800/WS3820 will display the corresponding unit and value on the screen. Units set by the Ecovitt App or Ecovitt.net website will not be synchronized to the receiver.

3.3.9 Rainfall

1. Rainfall Definition:

Rate/H: The last 10 minutes of rainfall multiplied by 6.

Event: If the last 24-hour rainfall is less than 1 mm and the last 1 hour has not had rainfall, the rain event is over.

Daily: Rainfall from 0:00 to 24:00, reset time can be set on the App.

Weekly: The rainfall of Sunday ~ Saturday/Monday ~ Sunday, the start time can be set.

Monthly: Rainfall of a natural month.

Yearly: Rainfall of a year, the start month can be set.

Total: Running total since station was powered up.

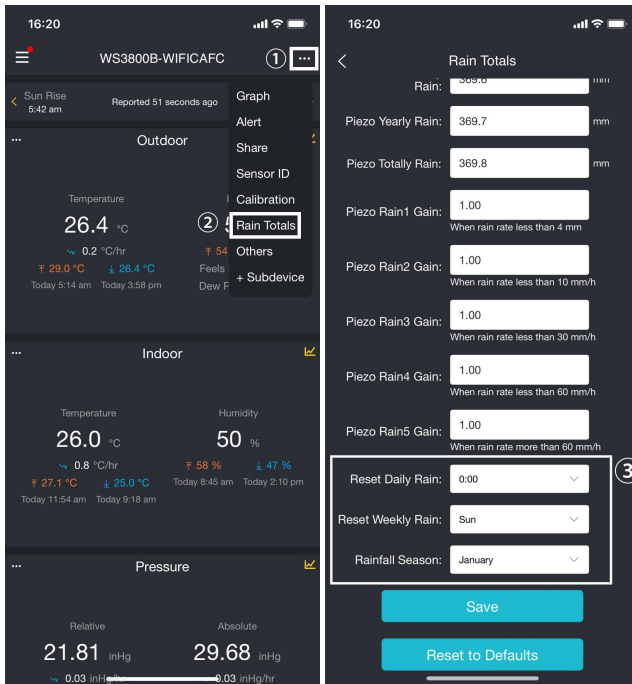




Figure 28: Reset Daily, Weekly and Rainfall Season

2. Rainfall display priority:

Traditional rainfall: WH40  > WS69 

Piezoelectric rainfall: WS85  > WS90 

3. Display rules

The WS3800/WS3820 can display either rainfall or piezoelectric rainfall, simply by selecting the rainfall rule you want to display via the "Rainfall data priority" on the App or web page.

4. Units

Refer to 3.3.8 Wind units setting.

3.3.10 UVI

The UV index varies between 0 ~ 15. The bar graph is divided into 6 levels of display.

- Level 5: $12 < \text{value} \leq 15$, EXTREME
- Level 4: $9 < \text{value} \leq 12$, VERY HIGH
- Level 3: $6 < \text{value} \leq 9$, HIGH
- Level 2: $3 < \text{value} \leq 6$, MODERATE
- Level 1: $0 < \text{value} \leq 3$, LOW
- Level 0: $0 = \text{value}$, (no display)



e.g.:

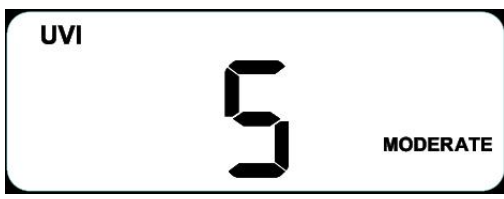


Figure 29: UVI

3.3.11 Moon Phase










The WS3800/WS3820 will be set to the Southern or Northern Hemisphere by default depending on the RF frequency:

915/868MHz: Northern Hemisphere

433MHz: Southern Hemisphere

The following moon phases are displayed based on the calendar date.

Northern Hemisphere:

								
New Moon	Waxing Crescent	First Quarter	Waxing Gibbous	Full Moon	Waning Gibbous	Third Quarter	Waning Crescent	New Moon

Southern Hemisphere:










								
New Moon	Waxing Crescent	First Quarter	Waxing Gibbous	Full Moon	Waning Gibbous	Third Quarter	Waning Crescent	New Moon

Table 4: Moon phase

3.3.12 Feels Like

Feels Like measurement range: $-40^{\circ}\text{F} \sim 140^{\circ}\text{F}$ ($-40^{\circ}\text{C} \sim 60^{\circ}\text{C}$).

When the outdoor temperature is less than 50°F (10°C), the value of Feels Like is wind chill.

When the outdoor temperature is greater than or equal to 50°F (10°C) and less than or equal to 80°F (26.7°C), the value of Feels Like is the outdoor temperature.

When the outdoor temperature is greater than 80°F (26.7°C), the value of Feels Like is the heat index.

Users have the option to choose between "Feels Like Temperature" and "Apparent Temperature" on the App or ecowitt.net.

Take the App as an example: Open Ecowitt App → "Menu" → "Settings" → "Temp Index" → "Feels Like Temperature" or "Apparent Temperature".

If the user selects "Apparent Temperature", the numerical value for "Feels Like" on the LCD screen will be displayed as the value of "Apparent Temperature".

3.4 LCD Display Brightness

The WS3800/WS3820 has 5 levels of brightness, which are Max → High → Medium → Low → Off.

A. When Battery Powered:

When the battery power is supplied, pressing any button will turn on the backlight, and the brightness will turn off automatically after 15s without button operation. When only battery powered, the brightness is only "Max" and "Off".

Note: 3 fresh AA alkaline or lithium batteries can run for 15~25 days.

B. When DC Powered:

1. The brightness will be adjusted to "Medium" automatically when the DC power supply is connected.
2. After disconnecting the DC power supply, the backlight will keep the brightness for 15s and then turn off.
3. When DC power is supplied, press **LIGHT** to adjust the brightness:
Max → High → Medium → Low → Off.

C. Automatic Control Backlight:

Version 1.3.0 and later support automatic backlight settings for web page. Please refer to **section 2.2.4** to access webpage settings.

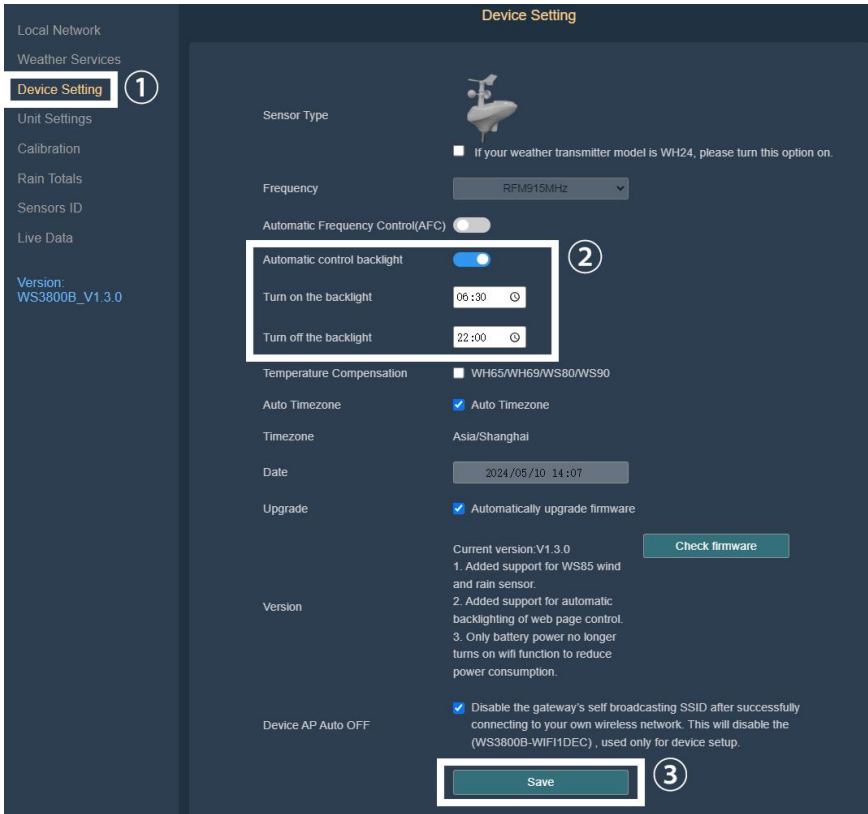


Figure 30: Automatic Control Backlight

3.5 Buttons

There are 8 buttons in total: **SET**, **TEMP**, **RAIN**, **PRE**, **WIND**, **+**, **-**, **LIGHT**.

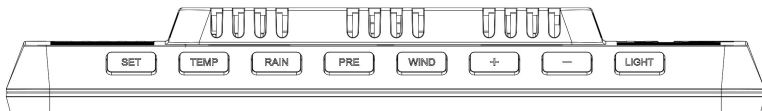


Figure 31: 8 Buttons

There are 8 buttons on the top of the display console. The following tables briefly explain the function of these buttons.

Buttons	Functions
SET	<p>Setting button</p> <p>Press to switch MAX/MIN/Alarm setting/MAC mode.</p> <p>Press to switch setting option in setting mode.</p> <p>Hold to enter setting mode.</p> <p>Hold SET + LIGHT for a factory reset.</p>
TEMP	<p>Temperature display button</p> <p>Press to switch temp channel.</p> <p>Hold to register weather data from sensor.</p> <p>Hold TEMP & + to activate Wi-Fi hotspot/configuration.</p>
RAIN	<p>Rain display button</p> <p>Press to switch RAIN RATE/EVENT/DAILY/WEEKLY/MONTHLY/YEARLY/TOTAL.</p>
PRE	<p>Pressure display button</p> <p>Press to switch REL/ABS mode.</p>
WIND	<p>Wind display button</p> <p>Press to switch WIND/GUST/DIRECTION/10min direction.</p> <p>Press to activate/deactivate alarm in alarm setting mode.</p>
+	<p>Plus button</p> <p>Press to switch display in the Date area.</p> <p>Press + to adjust value in setting mode.</p>
+	<p>Reduce button</p> <p>Press to switch UVI/sunrise & sunset.</p> <p>Press + to adjust value in setting mode.</p> <p>Hold TEMP & + to activate Wi-Fi hotspot/configuration.</p>
LIGHT	<p>Brightness adjustment button</p> <p>Press to adjust backlight when powered by DC.</p> <p>Press LIGHT to snooze and press the other to exit while alarming.</p> <p>Hold LIGHT to exit while snoozing.</p> <p>Hold SET & LIGHT for a factory reset.</p>

Table 5: Button functions

3.6 Product Modes

There are 5 modes in total: Normal mode, Setting mode, Max/Min value mode, Alarm setting mode, and MAC address display.

3.6.1 Normal Mode

1. The product will enter the main page of Normal mode by default when it is normally powered on. In other modes, no button operation for 30 seconds or press **LIGHT** can also return to the main page of normal mode.

2. In Normal mode, press **SET** to change the mode.

Sequence: Normal mode → Maximum value → Minimum value → Alarm setting → MAC address display.

3. Press **TEMP** in Normal mode to switch the display: OUTDOOR → FEELSLIKE → DEW → CH1 → CH2 → CH3 → CH4 → CH5 → CH6 → CH7 → CH8 → Auto-Scroll mode.

4. Hold **TEMP** for more than 5 seconds in OUTDOOR, FEELSLIKE or DEW display mode will re-register all non-disabled states outdoor temperature and humidity transmitters (WN32/WS90/WS80/WS69).

5. Hold **TEMP** for more than 5s in single CH mode will re-register the corresponding CH sensor.

6. Hold **TEMP** for more than 5s in ↻ Auto-Scroll mode will re-register the WN32, WS90, WS80, WS69 and CH1~CH8 sensors.

7. RAIN and PRESSURE share the same display area:

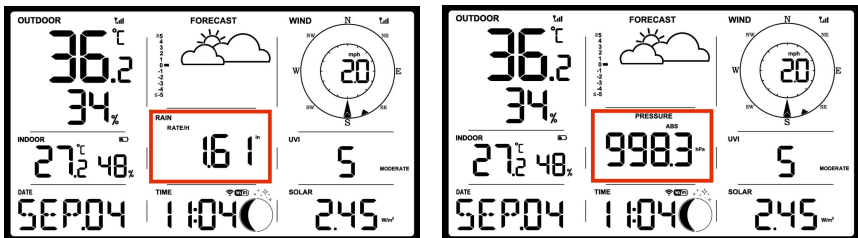


Figure 32: Switching display of rainfall and pressure

- ① Press **RAIN** to switch RAIN RATE/EVENT/DAILY/WEEKLY/MONTHLY/YEARLY/TOTAL display.
- ② Press **PRE** to switch PRESSURE ABS/REL display.
- ③ If the current display is RAIN, press **PRE** to switch to PRESSURE ABS/REL display. On the other hand, press **RAIN** to switch to rain display.

Notes:

- * In ↻ Auto-Scroll mode, only registered sensors are displayed.
- * Max and Min values will be cleared together if the multi-channel temperature and humidity sensor is re-registered.

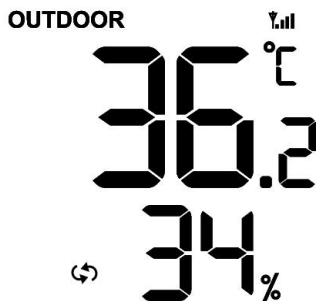


Figure 33: Auto-Scroll mode

8. Press **WIND** to switch WIND/GUST/DIRECTION/10min direction display. Numbers indicate the angle of the wind direction.
9. Press **+** to switch Date/CO₂/PM1.0/PM2.5/PM10/AQI display.
10. Press **□** to switch to UVI/Solar radiation/Sunrise/Sunset display. The exponential intensity graph on the right side synchronizes the display of UVI values.
11. When DC power is supplied, press **LIGHT** on the main page to adjust the backlight in 5 levels: Max → High → Medium → Low → Off.
12. Hold **TEMP** + **□** for more than 2s to open hotspot, Wi-Fi signal icon fast flash, you can connect to this hotspot on a mobile phone or PC.
13. Hold **SET** + **LIGHT** for 5 seconds the device will restore factory settings and reboot, and all setup parameters will be cleared.

3.6.2 Setting Mode

In Normal mode, hold **SET** for more than 2s to enter Setting mode. Then press **SET** to switch the setting item, press the **+** or **-** button to adjust the setting value:

- ① Beep sound (ON/OFF)
- ② RST daily High and Low reset switch
- ③ Hour format (12 hours/24 hours)
- ④ Hour setting
- ⑤ Minute setting
- ⑥ Year setting
- ⑦ Month setting
- ⑧ Day setting
- ⑨ Pressure unit selection (inHg, mmHg, hPa)
- ⑩ Relative pressure setting (700hPa-1100hPa)
- ⑪ Temperature unit selection ($^{\circ}\text{C}$, $^{\circ}\text{F}$)
- ⑫ Wind speed unit selection (mph, knots, BFT, m/s, km/h)
- ⑬ Rainfall unit selection (in, mm)
- ⑭ Solar Light unit selection (W/m², Kfc, Klux)
- ⑮ Selection of the northern and southern hemispheres (NTH, STH)

3.6.3 Max/Min Value Mode

In Normal mode, press **SET** to enter Max/Min value mode.

Sequence: Normal mode → Maximum value → Minimum value.

Max value: outdoor/indoor temperature & humidity, feels like, dew point, pressure, rainfall, wind speed, gust speed, UVI, and solar radiation.

Min value: outdoor/indoor temperature & humidity, feels like, dew point, and pressure.

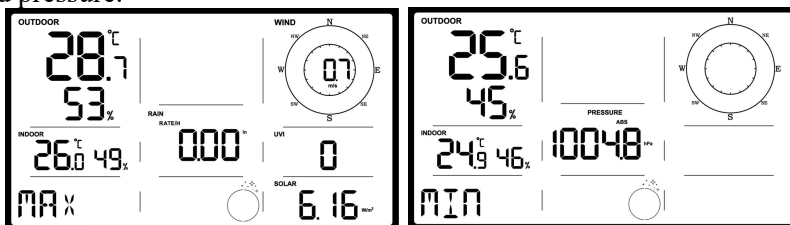


Figure 34: Max/Min value mode

3.6.4 Alarm Setting Mode

A. Alarm Function

In Normal mode, press **SET** to enter Alarm setting mode.

Sequence: Normal mode → Maximum value → Minimum value → Alarm setting.

In the alarm setting mode, press **SET** to switch the alarm clock setting item:

- ① Alarm hour setting
- ② Alarm minute setting

Press **+** or **-** to adjust the value. Press **WIND** to switch on/off the alarm.

After the alarm is triggered, the alarm will continue to sound for 2 minutes when no button is pressed, and the alarm will become more and more rapid within these 2 minutes.

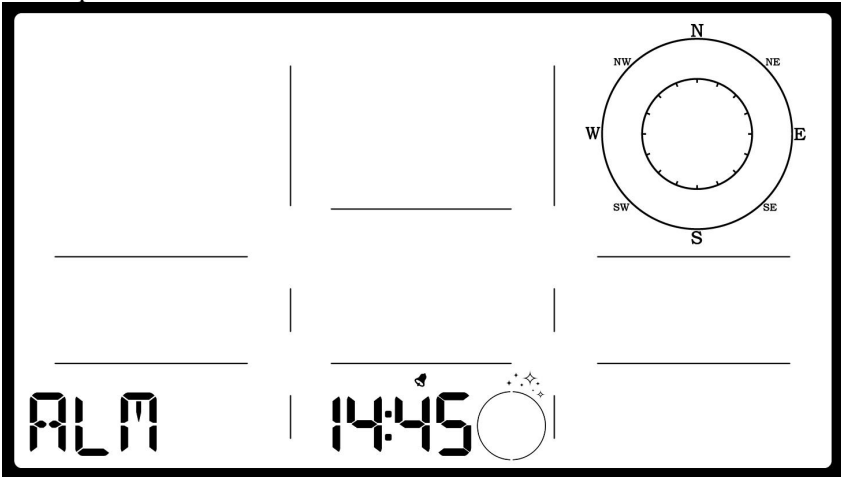



Figure 35: Alarm setting

B. Snooze Function

When the alarm clock is set and the alarm is triggered, press **LIGHT** to enter snooze mode, the snooze icon **z^z** will be displayed near the alarm clock icon , and the alarm will sound again after 10 minutes.

Hold any button for 2 seconds after entering snooze mode will exit snooze mode.



Figure 36: Snooze function

3.6.5 MAC Address Display

In Normal mode, press **SET** to change the mode.

Sequence: Normal mode → Maximum value → Minimum value → Alarm setting → MAC address display.

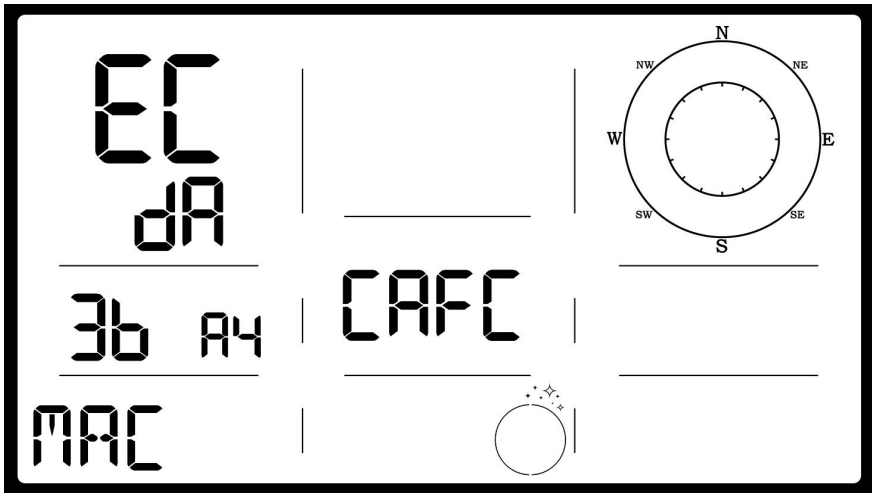


Figure 37: MAC address: EC:DA:3B:A4:CA:FC

3.7 Historical Data Export and Clear

3.7.1 Export History Data:

WS3800/WS3820 doesn't support a memory card to store data, when the Wi-Fi configuration (refer to **Section 2.2** for Wi-Fi Configuration) is completed, you can log in to Ecowitt.net to export the data in **xlsx** file format.



Figure 38: Export Historical Data from Ecovitt.net

Note:

- Data with a query period of days/24 hours is retained for 3 months.
- Data with a weekly query period is retained for 1 year.
- Data with a monthly query period is retained for 2 years.
- Data with a yearly query period is retained for 4 years.

3.7.2 Clear History Data:

Under "menu" → "devices" → "... " → "Sure".

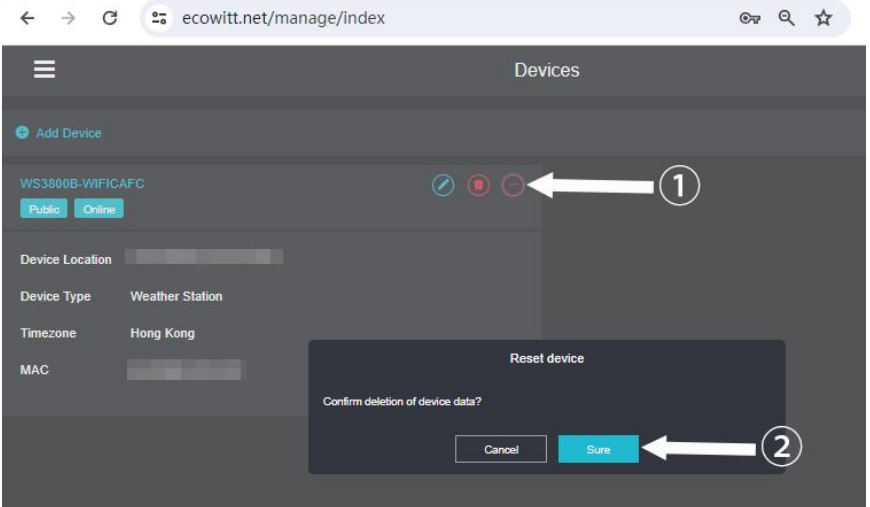


Figure 39: Clear History Data

3.8 Firmware Upgrade

Method 1: Via Ecowitt App

Open Ecowitt App → My Devices → "... " (Open the Edit Gateway page) → tap the firmware version number to upgrade if there is a new version available. When the upgrade is complete, the WS3800/WS3820 will reboot into the latest version.

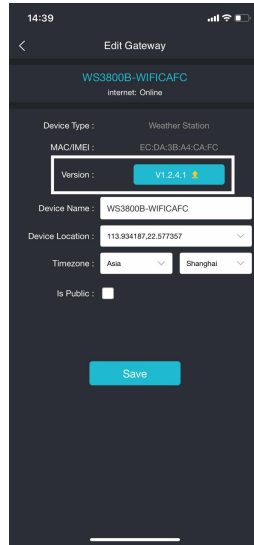


Figure 40: Upgrade Firmware on the App

Method 2: Via web page 192.168.4.1

If you choose "Automatically upgrade firmware" on the web page 192.168.4.1 (refer to **Section 2.2.4** to access the web page), WS3800/WS3820 will enter OTA every time when there is a new firmware, and the screen will display the "OTA" character. When the automatic firmware update is successful, it will display "OTA OK" and reboot automatically. (Automatic update interval is 24 hours).

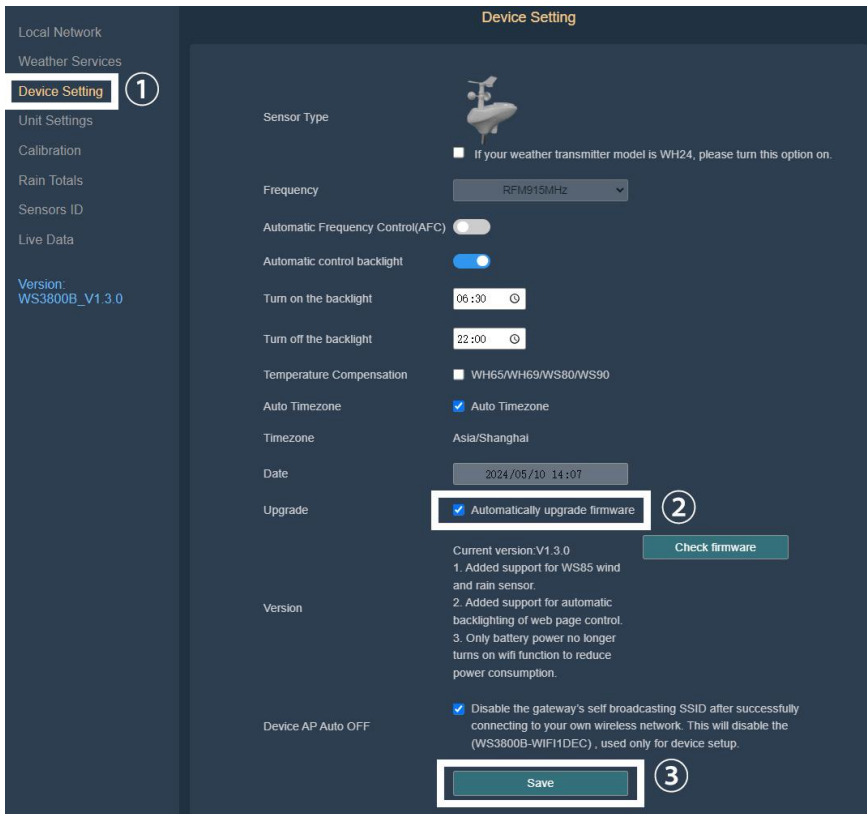


Figure 41: Automatically upgrade firmware setting on the web page

4. Optional Sensors

The RF reception function will always be turned on to receive data from multiple sensors at any time.

4.1 Sensors








When powered by DC or battery, the device supports these sensors as below, power consumption can be high if only battery power is available.

The following sensors can be purchased separately. For more information, please visit our website: <http://www.ecowitt.com>. Make sure to select the model of the units with the same RF frequency as your gateway or

display (the frequency is different for various countries because of regulations).

Note: Max QTY of the following table means the maximum number of different sensors that can be connected to the WS3800/WS3820.

4.1.1 Sensor Data Can be Displayed on the WS3800/WS3820

Sensor Model	Max QTY	Picture	Functions
WS90	1		Outdoor temperature & humidity, light, UV, wind speed/direction, rainfall
WS85	1		Wind speed/direction, rainfall
WS80	1		Outdoor temperature & humidity, light, UV, wind speed/direction
WS69	1		Outdoor temperature & humidity, light, UV, wind speed/direction, rainfall
WS68	1		Light, UV, wind speed/direction
WH40	1		Rainfall
WN32P	1		Indoor temperature, humidity and pressure






WN32	1		Outdoor temperature and humidity
WH45/WH46	1		WH45: CO ₂ , PM2.5, PM10, temperature and humidity WH46: CO ₂ , PM1.0, PM2.5, PM4.0, PM10, temperature and humidity
WN31	8		Temperature and humidity
WN30			Temperature
WN36			Pool temperature

Table 6: Optional sensors

Note:

1. Some data of WS90/85/80/69/68/WH40/WN32 exist display priority, please refer to **Section 3.3.7~3.3.9**.
2. Some data of WH45/WH46 would not show on the WS3800/WS3820. Please refer to **Section 3.3.2**.

4.1.2 Sensor Data Can Only be Uploaded to the Cloud








Sensor Model	Max QTY	Picture	Functions
WH57	1		Lightning detection
WH41/WH43	4		PM2.5
WH55	4		Water leak detection
WH51L	8		Soil moisture
WH51			Soil moisture
WN34L/S/D	8		Temperature
WN35	8		Leaf wetness

Table 7: Optional sensors

4.2 IoT Device:



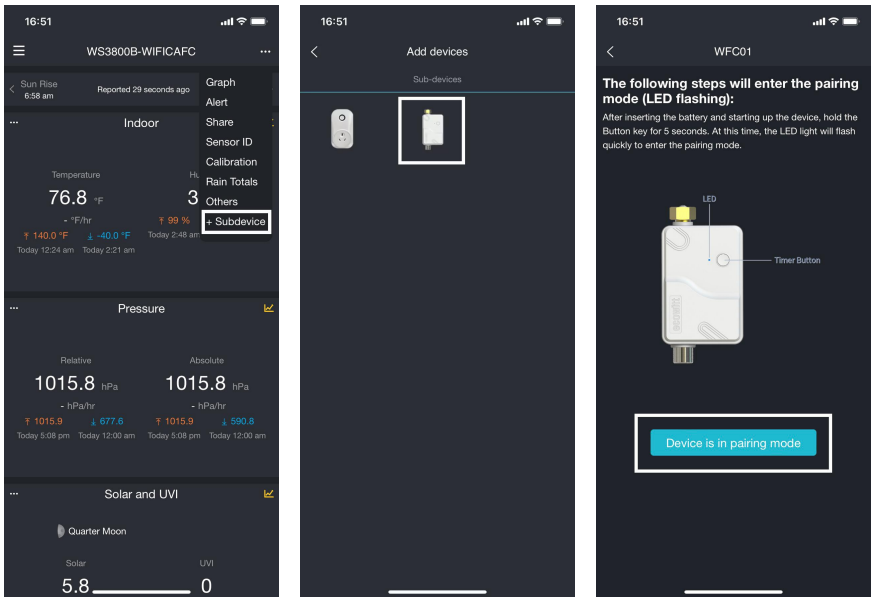
Sensor Model	Max QTY	Picture	Functions
WFC01	16		Smart water timer
AC1100			Smart plug

Table 8: IoT device

After the Wi-Fi configuration of WS3800/WS3820 is finished (refer to **Section 2.2**), IoT products can be connected to the App in two methods. Take WFC01 for an example:

4.2.1 Method 1 to Add Sub-devices



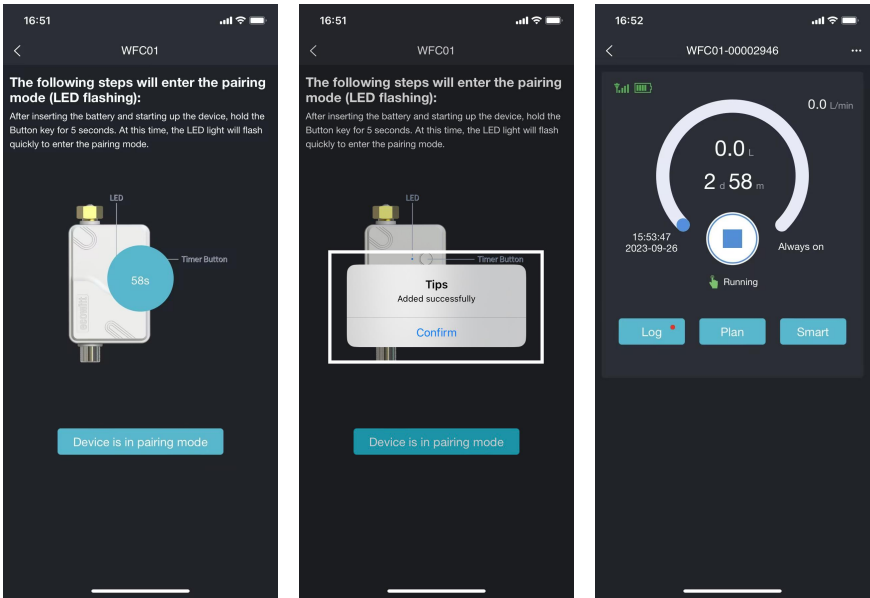
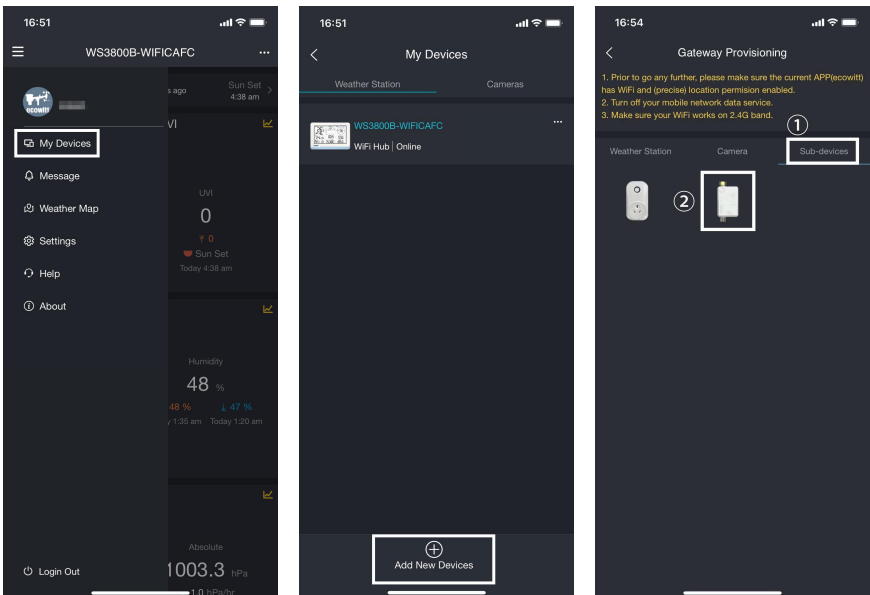


Figure 42: Method 1 to connect IoT device

4.2.2 Method 2 to Add Sub-devices



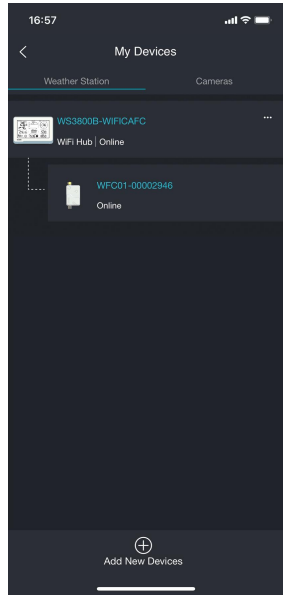
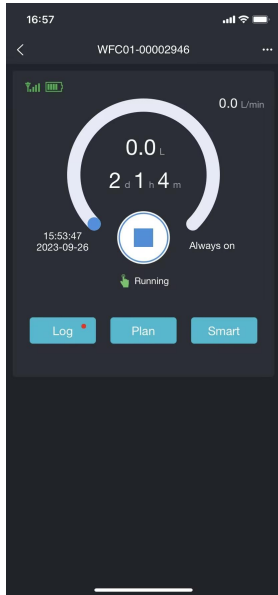
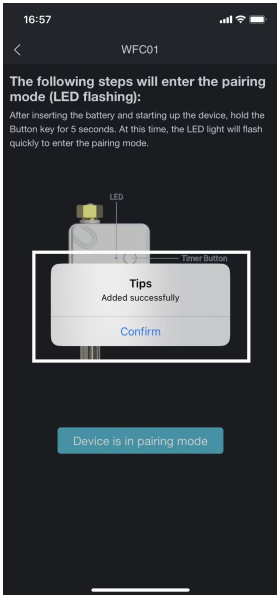
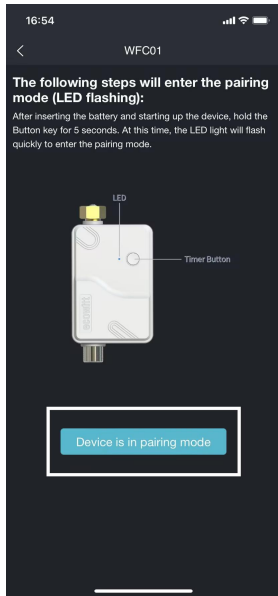
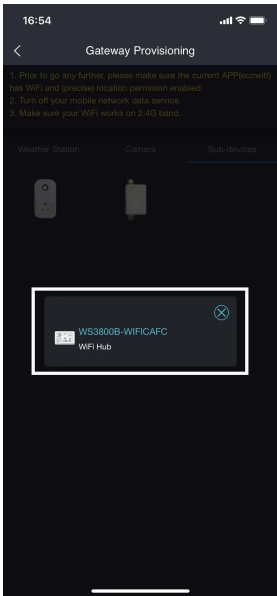


Figure 43: Method 2 to connect IoT device

5. Calibration

5.1 Data Calibration

If you have data from a relatively accurate weather station. You can use the data to do the calibration.

1. Make sure your mobile device is connected to the same Wi-Fi network that WS3800/WS3820 is connected to.
2. Click "... " on top right corner and choose "Calibration".
3. For a certain parameter (Take Outdoor temperature as an example in the **Figure 44**). Calculate the offset of data from accurate weather station and ecowitt sensor.
4. Fill in the offset got from step3, click Save.

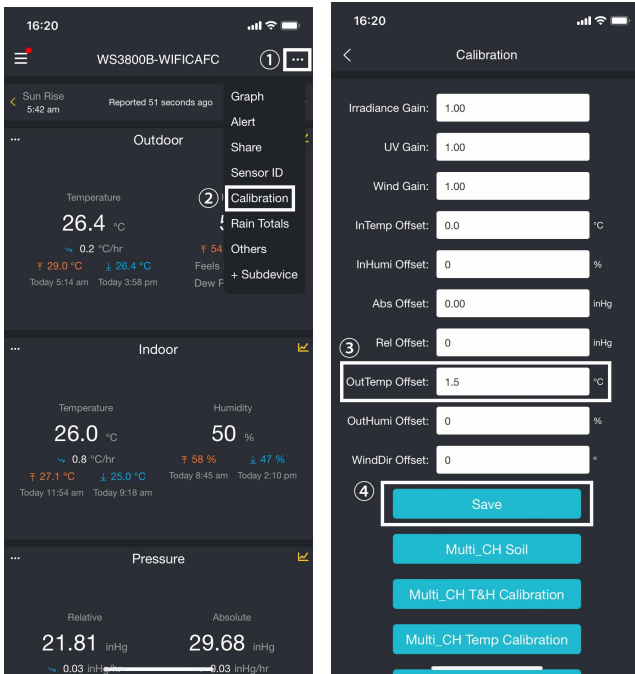


Figure 44: Data Calibration

5.2 Rainfall Calibration

The access steps are shown in **Figure 45**.

Take the **Traditional rain gauge** as an example:

Suppose your device measures a daily rainfall of 2.5mm, while another device (assuming it's a super pro device) measures a daily rainfall of 2.6mm. Therefore, we calibrate the “**Rain Day**” to 2.6mm.

Or we set **Rain Gain** to $2.6/2.5 = 1.04$. Then the rainfall will be calibrate to: $2.5 * 1.04 = 2.6$ mm. Only when different rainfall is recorded does the gain index take effect.

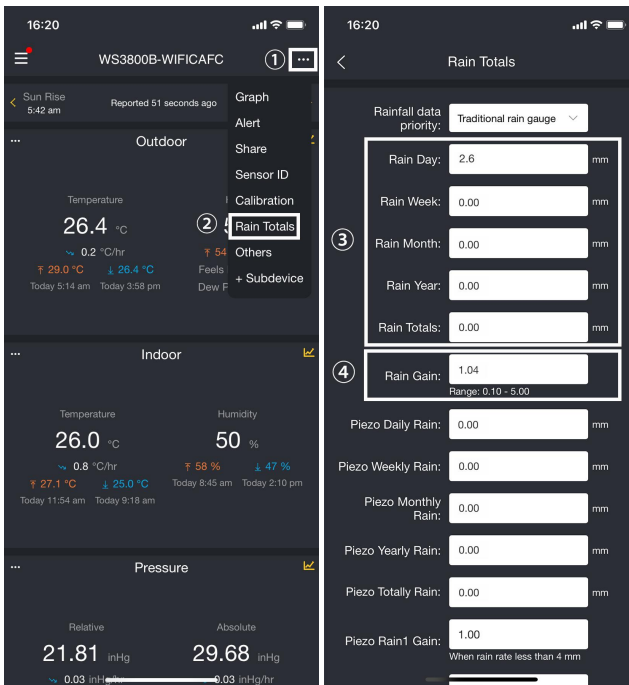


Figure 45: Rainfall Calibration

6. Others

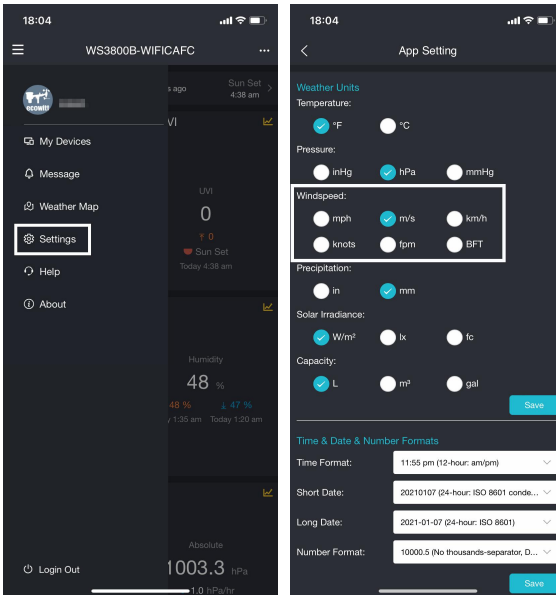
6.1 Lightning Distance Unit

WS3800/WS3820 can connect one WH57 lightning sensor, and the lightning data can only be viewed through Ecowitt App, website, and web page, if you need to modify the lightning distance unit, you can modify it by modifying the wind speed unit on the App, website or web page.

We here recommend modifying units on the App, the lightning units will be used in daily viewing and exporting data on the website.

Wind Speed Unit	Lightning Distance Unit
m/s, km/h, BFT	km
knots	nmi
mph, fpm (fpm can only be set in App/website)	mi

Table 9: Corresponding table of wind speed and lightning distance units



Note: The wind speed units set on the App will not be synchronized to the WS3800/WS3820.

Figure 46: Setting lightning units by setting wind speed units on the App

7. Specifications

Model	WS3800/WS3820
Name	Weather Station (receiver)
Dimensions	8.2 x 5.6 x 1.1 inch
Screen Size	6.6 x 3.7 inch
Weight	368.9(g)
Material of Plastic Casing	ABS
Material of Screen	HTN-LCD
Temperature Metering Range	-9.9°C to 60°C (14°F to 140°F)
Temperature Metering Accuracy	±0.2°C (±0.4°F)
Temperature Metering Resolution	0.1°C (0.2°F)
Humidity Metering Range	1% to 99%
Humidity Metering Accuracy	±2%
Humidity Metering Resolution	1%
Barometric Pressure Metering range	300 to 1100 hPa (8.85 to 32.5 inHg)
Barometric Pressure Metering accuracy	±1.5hpa (absolute pressure); ±2hpa (relative pressure)
Barometric Pressure Metering resolution	0.1 hPa (0.01 inHg)
Reading Update Interval	About 1 minute
RF Connection Frequency	915/868/433MHz (depending on local regulations)
RF Wireless Range	Over 100 meters (in open areas)
WLAN	802.11 b/g/n 2.4 GHz (802.11n, Max 150 Mbps)
WLAN Range	Over 30 meters (in open areas)
Console Operating Temperature	-10°C to 50°C (14°F to 122°F)
Power Supply	DC 5V 1A or 3 fresh AA alkaline/lithium batteries (not included)
Battery Life	15~25 days (Back-up only)

Table 10: Specifications

Note: When working with other transmitters, the screen displays the following range of data:

Indoor Temperature	-9.9 to 60°C
Outdoor Temperature	-40 to 60°C
Humidity	1% to 99%
Wind Speed	0 to 180km/h
Wind Direction	0 to 359 degrees
Rainfall	0 to 9999mm
UVI	0 to 15
Solar	0 to 300Klux
CO ₂	0 to 40000ppm
PM1.0, PM2.5, PM10	0 to 999ug/m ³
AQI	0 to 500

Table 11

8. Warranty and Certification

8.1 Warranty

We disclaim any responsibility for any technical error or printing error or the consequences thereof.

All trademarks and patents are recognized.

We provide a 1-year limited warranty on this product against manufacturing defects or defects in materials and workmanship.

This limited warranty begins on the original date of purchase, is valid only on products purchased, and only to the original purchaser of this product. To receive warranty service, the purchaser must contact us for problem determination and service procedures.

This limited warranty covers only actual defects within the product itself and does not cover the cost of installation or removal from a fixed installation, normal set-up or adjustments, or claims based on misrepresentation by the seller, or performance variations resulting from installation-related circumstances.

8.2 FCC

This device complies with part 15 of the FCC Rules. Operation is subject to the following conditions: (1) this device should not cause harmful interference, and (2) this device must accept any interference received, including interference that may cause undesired operation.

Changes or modifications not expressly approved by the party responsible for compliance could void the user's authority to operate the equipment.

NOTE: This equipment has been tested and found to comply with the limits for a Class B digital device, pursuant to Part 15 of the FCC Rules. These limits are designed to provide reasonable protection against harmful interference in a residential installation. This equipment generates, uses and can radiate radio frequency energy and, if not installed and used in accordance with the instructions, may cause harmful interference to radio communications. However, there is no guarantee that interference will not occur in a particular installation.

If this equipment does cause harmful interference to radio or television reception, which can be determined by turning the equipment off and on, the user is encouraged to try to correct the interference by one or more of the following measures:

- Reorient or relocate the receiving antenna.
- Increase the separation between the equipment and receiver.
- Connect the equipment to an outlet on a circuit different from that to which the receiver is connected.
- Consult the dealer or an experienced radio/TV technician for help.

To maintain compliance with RF Exposure guidelines, This equipment should be installed and operated with a minimum distance between 20cm of the radiator and your body. Use only the supplied antenna.

IC Caution:

English:

This device contains license-exempt transmitter(s)/receiver(s) that comply with Innovation, Science, and Economic Development Canada's license-exempt RSS(s). Operation is subject to the following two

Conditions:

1. This device may not cause interference.

2. This device must accept any interference, including interference that may cause undesired operation of the device.

French:

L'émetteur/récepteur exempt de licence contenu dans le présent appareil est conforme aux CNR d'Innovation, Sciences et Développement économique Canada applicables aux appareils radio exempts de licence.

L'exploitation est autorisée aux deux conditions suivantes :

1. L'appareil ne doit pas produire de brouillage;
2. L'appareil doit accepter tout brouillage radioélectrique subi, même si le brouillage est susceptible d'en compromettre le fonctionnement.

Manufacture: Shenzhen Fine Offset Electronics Co., Ltd.

Address: 4/F, Block C, JiuJiu Industrial City, Shajing Town, Baoan District, Shenzhen City, China

9. Care and Maintenance

When batteries of different brand or type are used together, or new and old batteries are used together, some batteries may be over-discharged due to a difference of voltage or capacity. This can result in venting, leakage, and rupture and may cause personal injury.

- Do not mix Alkaline, Lithium, standard, or rechargeable batteries.
- Always purchase the correct size and grade of battery most suitable for the intended use.
- Always replace the whole set of batteries at one time, taking care not to mix old and new ones, or batteries of different types.
- Clean the battery contacts and also those of the device prior to battery installation.
- Ensure the batteries are installed correctly with regard to polarity (+ and -).
- Remove batteries from product during periods of non-use. Battery leakage can cause corrosion and damage to this product.

- Remove used batteries promptly.
- For recycling and disposal of batteries, and to protect the environment, please check the internet or your local phone directory for local recycling centers and/or follow local government regulations

10. Contact Us

10.1 After-sales Service

Order Issues:

If you encounter any missing or incorrect shipments of Ecowitt products purchased, please reach out to the respective platform's customer service from the store where you bought the product for assistance.

Usage Inquiries:

Our product is continuously changing and improving, particularly online services and associated applications. To download the latest manual, and additional help, and for any issues related to product usage feel free to contact our customer support team at support@ecowitt.com. We are committed to providing assistance and resolving any concerns you may have.

10.2 Stay in Touch

Ask questions, watch setup videos, and provide feedback on our social media outlets. Follow Ecowitt on Discord, YouTube, Facebook and Twitter.

